



UP1-JR Reversible impeller pump 28 l/min with on/off integrated switch



Quick Overview

Professional range of self-priming electric 12V and 24V pumps for the refueling and transfer of water, oil and diesel with ON/OFF switch integrated into the water-proof cap. The -R versions are fitted with a 3 positions switch for the inversion of flow direction.

Part n.	Name	Voltage (V)	Consumption (A)	Fuse (A)	Self-priming (m)	Pressure (bar)	Flow rate (l/min)	Ports (BSP)	Hose (mm)	IP Protection	Motor power (W)	Weight (kg)
16201112	UP1-JR	12	8	10	1,5	1	28	3/8"	20	65	150	1,8
16201113	UP1-JR	24	4	7,5	1,5	1	28	3/8"	20	65	150	1,8

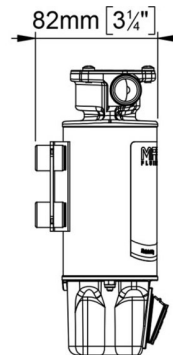
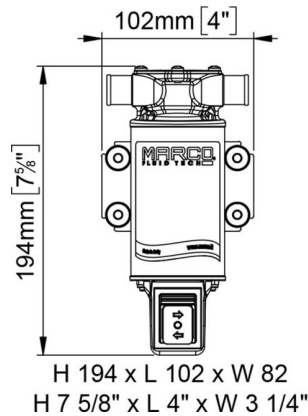
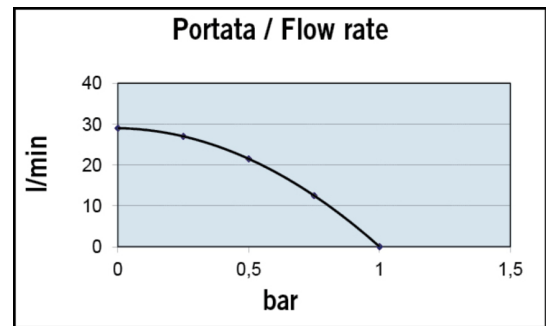
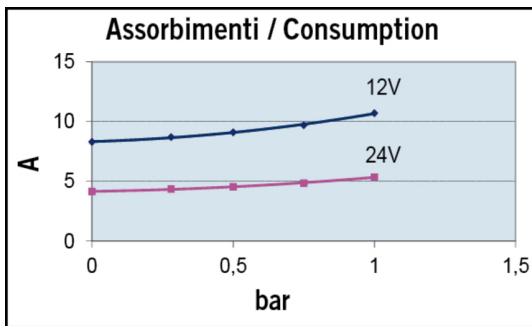



R6400109



R6400015



R6400112



R6400093



R6400108

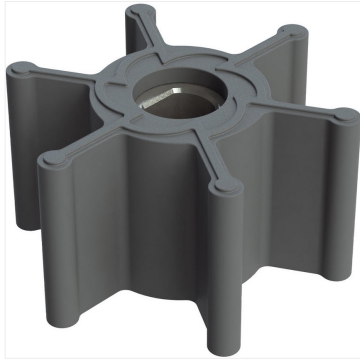

**IMP2 NBR Rubber impeller for
UP1-J**

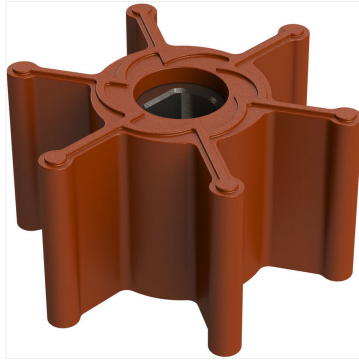

**IMP2/V FKM Rubber impeller for
UP1-J**

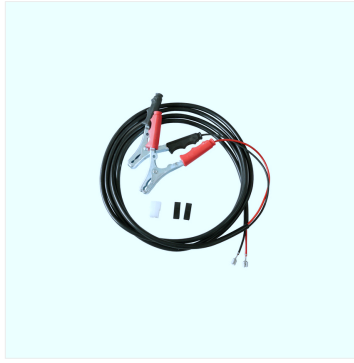

Kit of cables and battery clips