



IP45 Sun Awning Deck Socket

From

£160.44

Excl. Tax: £133.70

Product Images



Short Description

The IP45 deck socket is for use with the Ø45mm removable carbon fibre sun awning poles, both fixed and telescopic. CNC machined from billet 316-grade stainless steel, the socket is incredibly strong, long-lasting and beautiful. The softened edges result in a comfortable underfoot fixture.

The patented design of the socket means that it is very shallow and entirely waterproof. No drains are

needed with this fitting, resulting in an efficient and straightforward installation. The socket is supplied with a counterplate for load spreading.

The socket is available in two forms. A drilled and countersunk model for installation from above (4x M6) or a blind fitting version with 4x threaded M6 fixing points for installation from below.

Fixing screws and nuts are sold separately, please view the related products section to see available options.

Description

Deck Socket For Ø45mm Awning Poles



IC-IP4500SS Fixing From Above

SECTION A-A

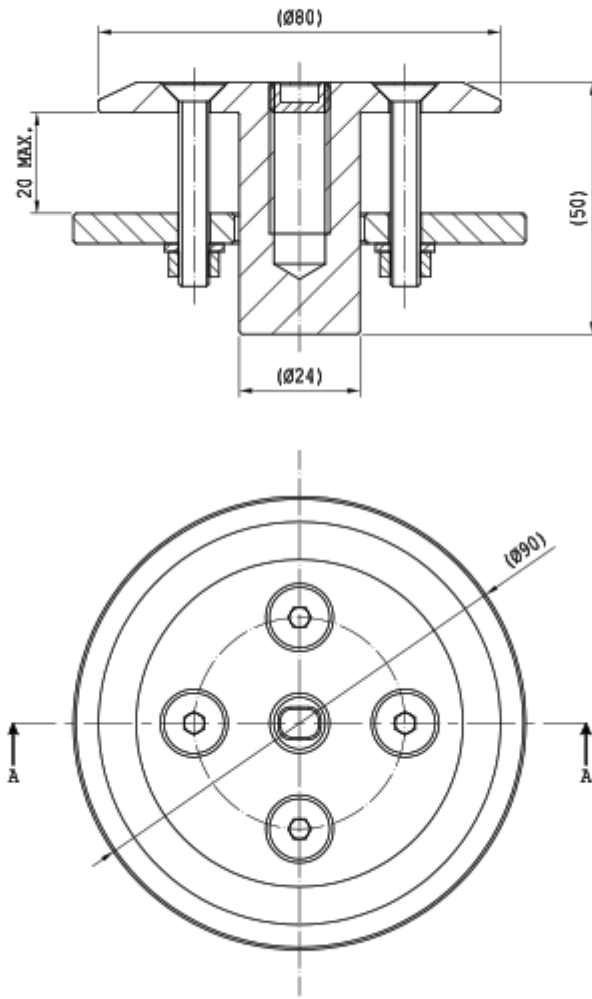

IC-IP4501SS Fixing From Underneath

SECTION A-A

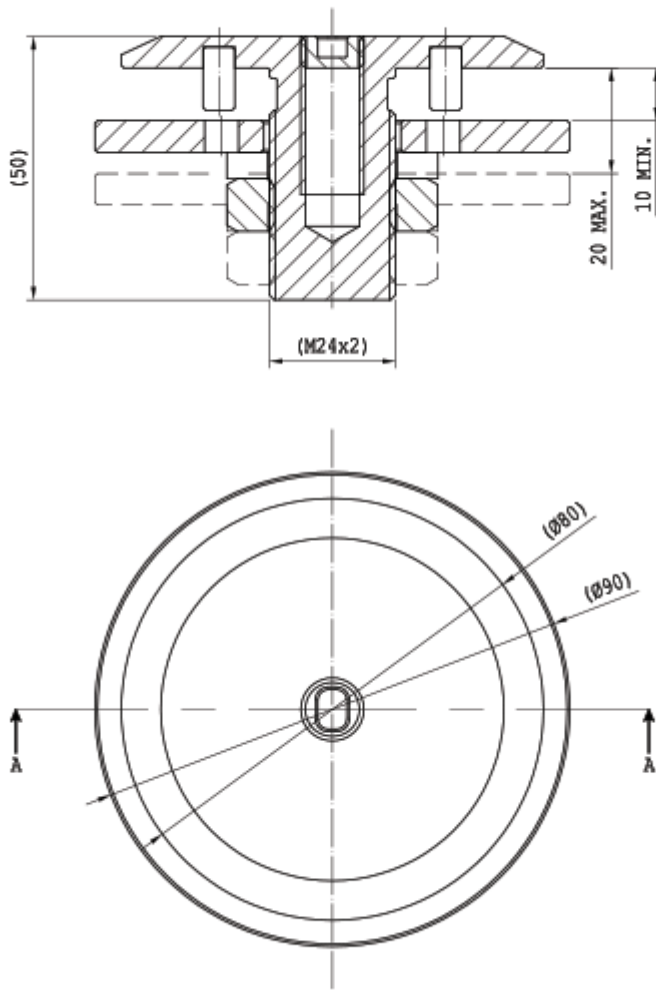

Additional Information

Weight (kg)	0.650000
Finish	316 Stainless Steel
Base Depth	40.00
Base Diameter (mm)	80.00
Recess Diameter (mm)	24.00

Product Options

Version:

Visible Screw Fixing

Blind Fixing From Underneath

