



Telescopic Ø86mm Carbon Fibre Removable Sun Awning Pole

£2,495.15

Excl. Tax: £2,079.29

Product Images



Short Description

A premium telescopic carbon fibre removable awning pole. This lightweight and strong awning pole is designed for use with the IP86 base (sold separately). The pole is simply wound into the socket when a

temporary sun awning is required, the fabric can then be quickly fastened to the pulley system and tensioned using the Clamcleat® device.

The system features plenty of neat design innovations such as the ability to rotate the pole once installed without unwinding the thread. The pulley rope is also hidden in the top section of the pole, only exiting the tube at the Clamcleat® tensioner. Finally, the compatible deck socket has an extremely shallow and waterproof design meaning that the poles can be easily placed, even in locations with little depth below the installation surface. No drainage is required for the socket.

The telescopic design means that this awning can reduce in length from its 2200mm maximum height to just 1400mm for stowage.

The poles are supplied in a matt carbon finish with stainless steel components.

Description

Telescopic Removable Awning System







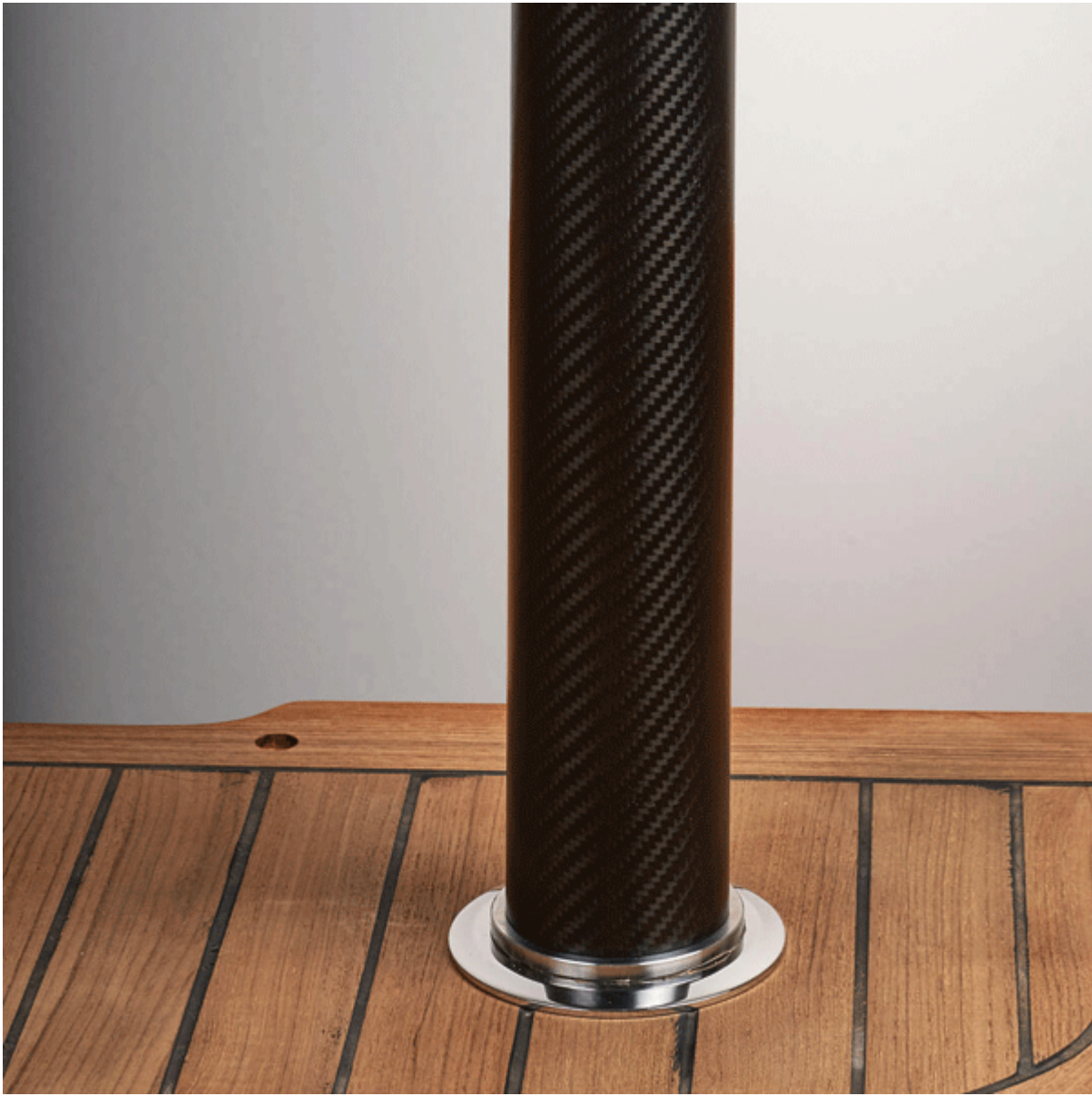

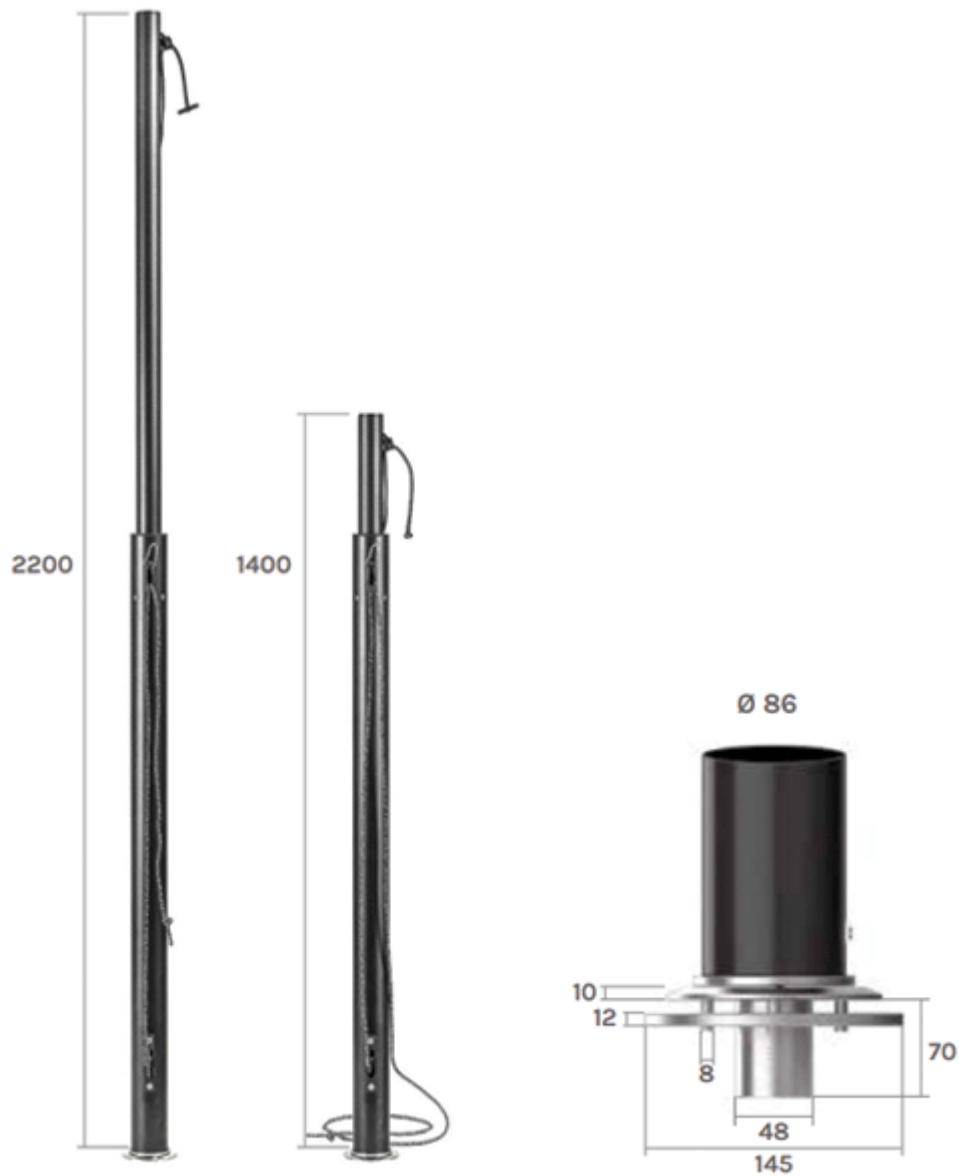

Pre-preg carbon fibre poles

1400mm minimum height when retracted

Storage bag included

Clear UV protective coating

Custom colour available on request

Lightweight and strong

Ø86mm pole system, Ø66mm also available

Internal pulley with Dyneema® rope and low friction rings

Patented deck base with backing plate

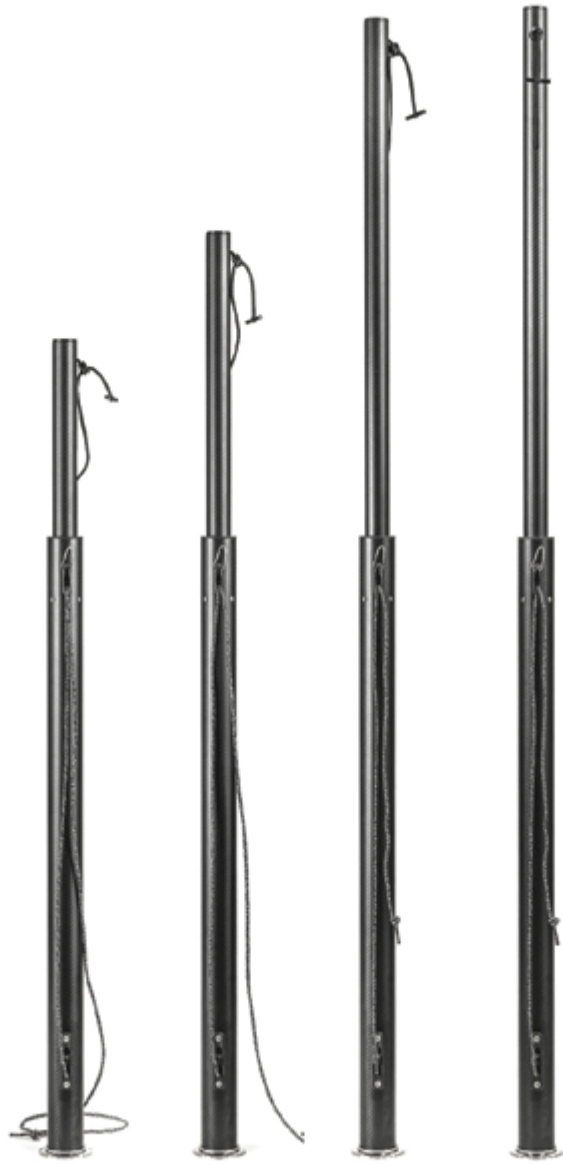



Additional Information

Weight (kg)	4.000000
Pole Height	2200.00
Pole Diameter	86.00
Finish	316 Stainless Steel & Matt Carbon Fibre

