



Galatea TG Spotlight

From

£132.11

Excl. Tax: £110.09

Product Images



Short Description

The Galatea spotlight packs a huge amount of technology into a very compact form. The Nichia™ LED chip produces a very high quality LED output with an average colour rendering index of 95. The spotlight is waterproof from both the front and rear and is available in various lens angles and colour temperatures. The extended bezel makes the fitting especially suitable for anti-glare applications.

- Interior & exterior spotlight
- Galvanised brass face, chrome plated
- Tempered glass lens
- Anodised aluminium heatsink
- Multiple lens angles available
- Available in numerous white colour temperatures as well as red
- CRI>90

Description





Heat Dissipation

Heat dissipation is key to the performance and longevity of LED lighting. Our Power LED modules have been carefully designed to ensure that the heat is taken away from the LED chips and dissipated through the incorporated heat sink designed into the product housing.

Circuit board temperatures are closely monitored during the development phase of each product and appropriate heat dissipation can then be accurately calculated to ensure that product will continue to perform for many years

Power Regulator

The 10-30Vdc power regulator is always a remote item on the power cable of the fitting. This offers numerous advantages over alternative methods used by competitor brands. Keeping the power regulator separate

reduces heat build-up on the LED circuit board and therefore increases performance and longevity of the LEDs.

Remote regulators can also be easily removed so that the product can be powered directly with the correct amperage, very useful for integration in some mains voltage applications.

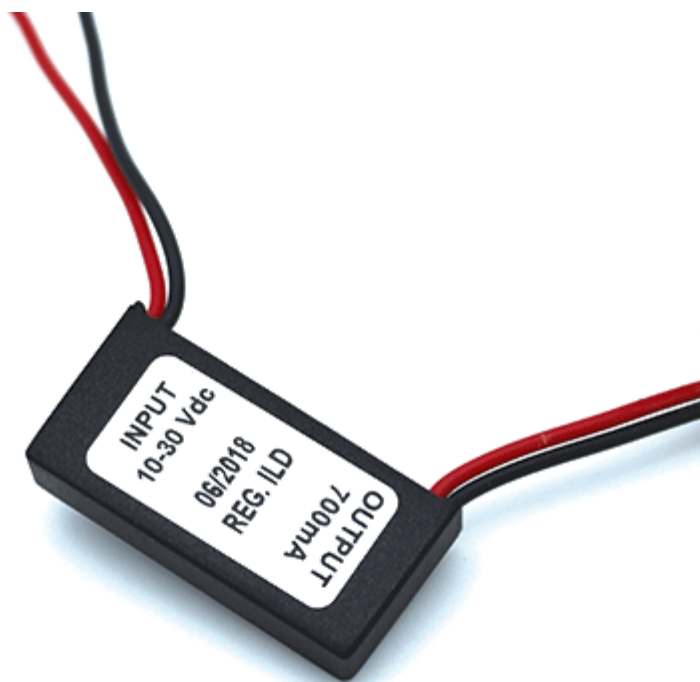



Not All Cones Are Equal

A choice of lens angles is available for this product which means that the perfect output can be selected for any given project. Selecting either standard, medium or narrow lenses can have a large effect on the overall lighting effect.

5250 44° Lens (.9)

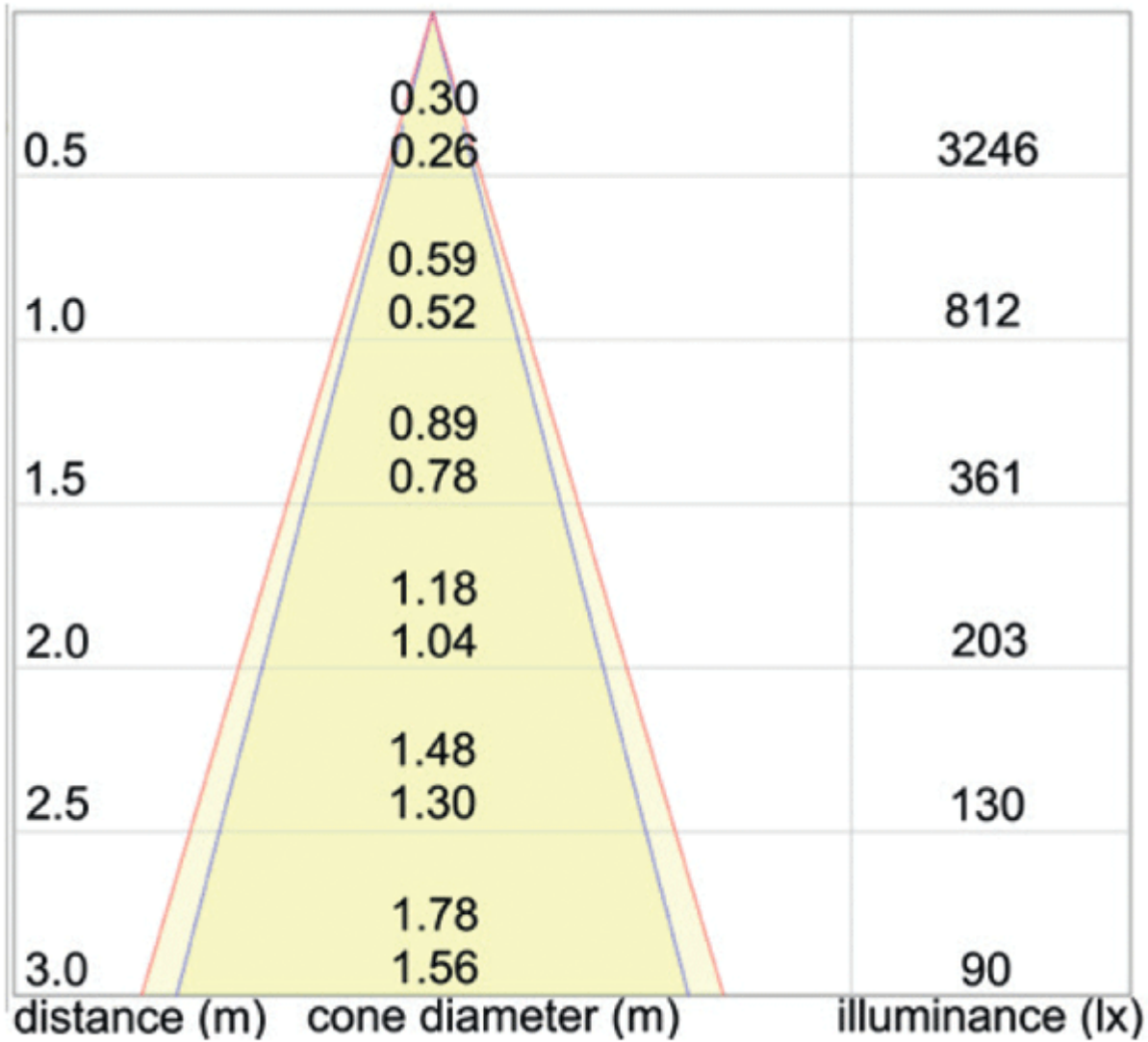

5250 44° Lens (.9)

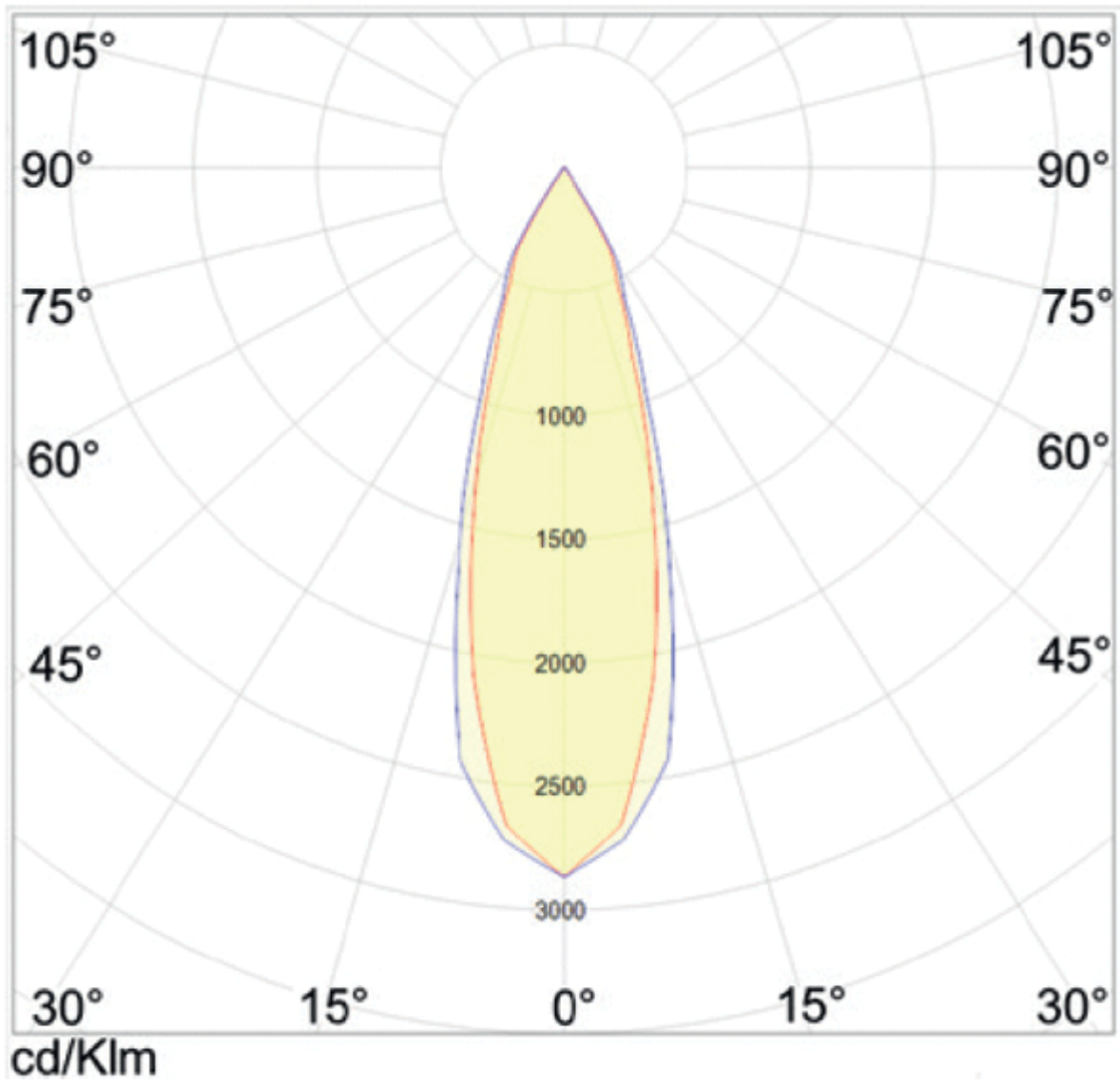

5250 29° Lens (.9M)

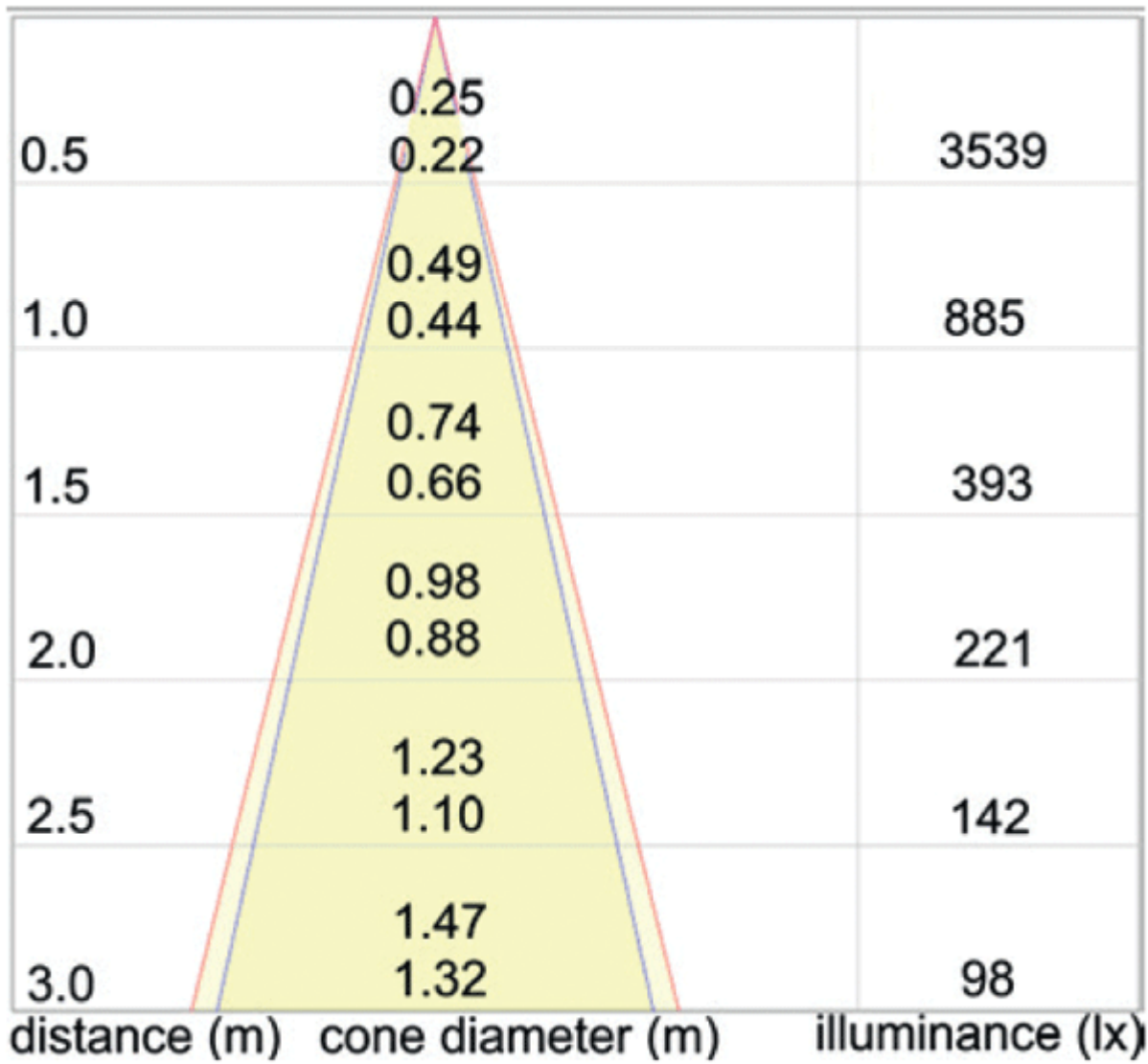

5250 29° Lens (.9M)

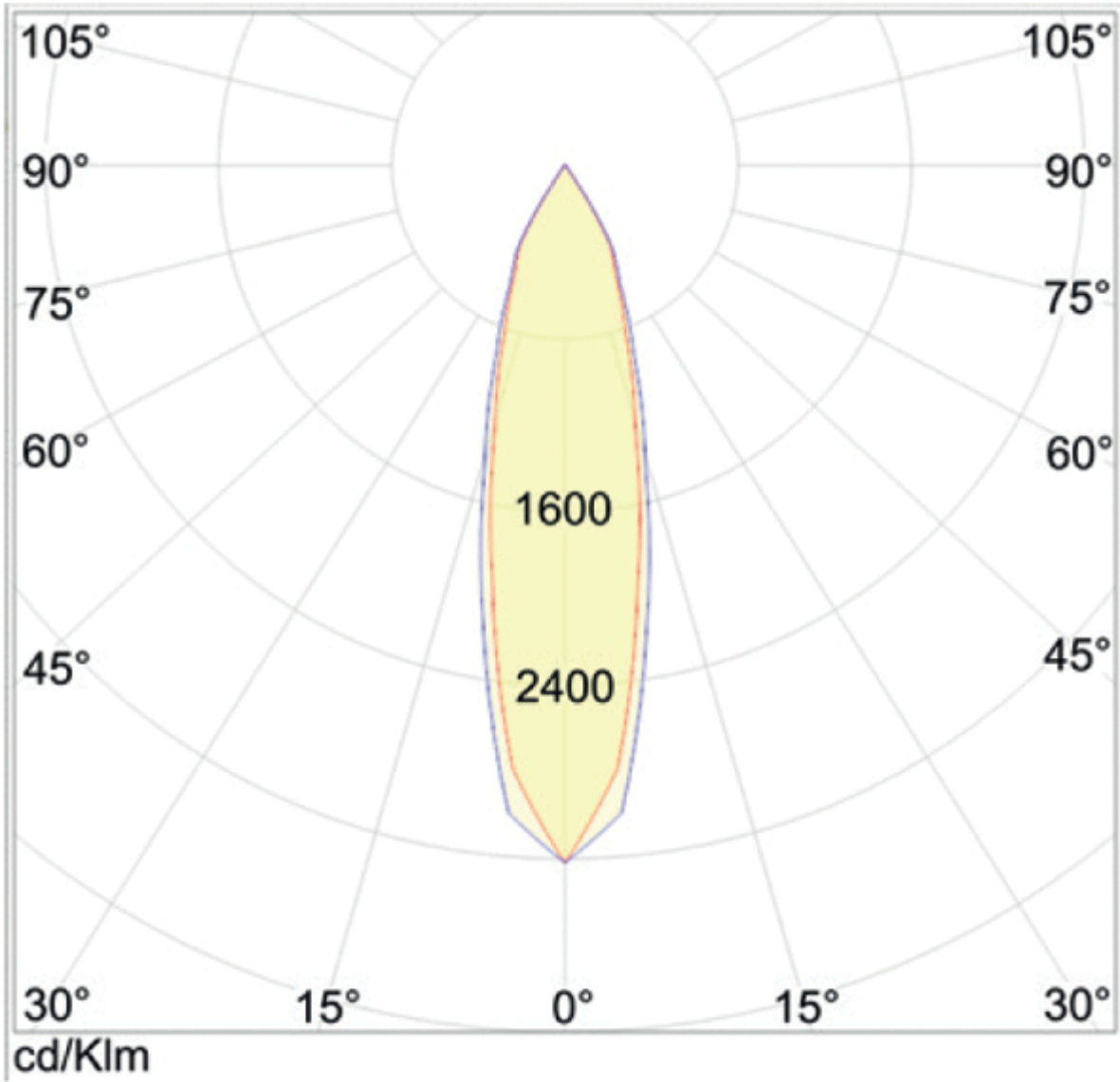

5250 14° Lens (.9N)

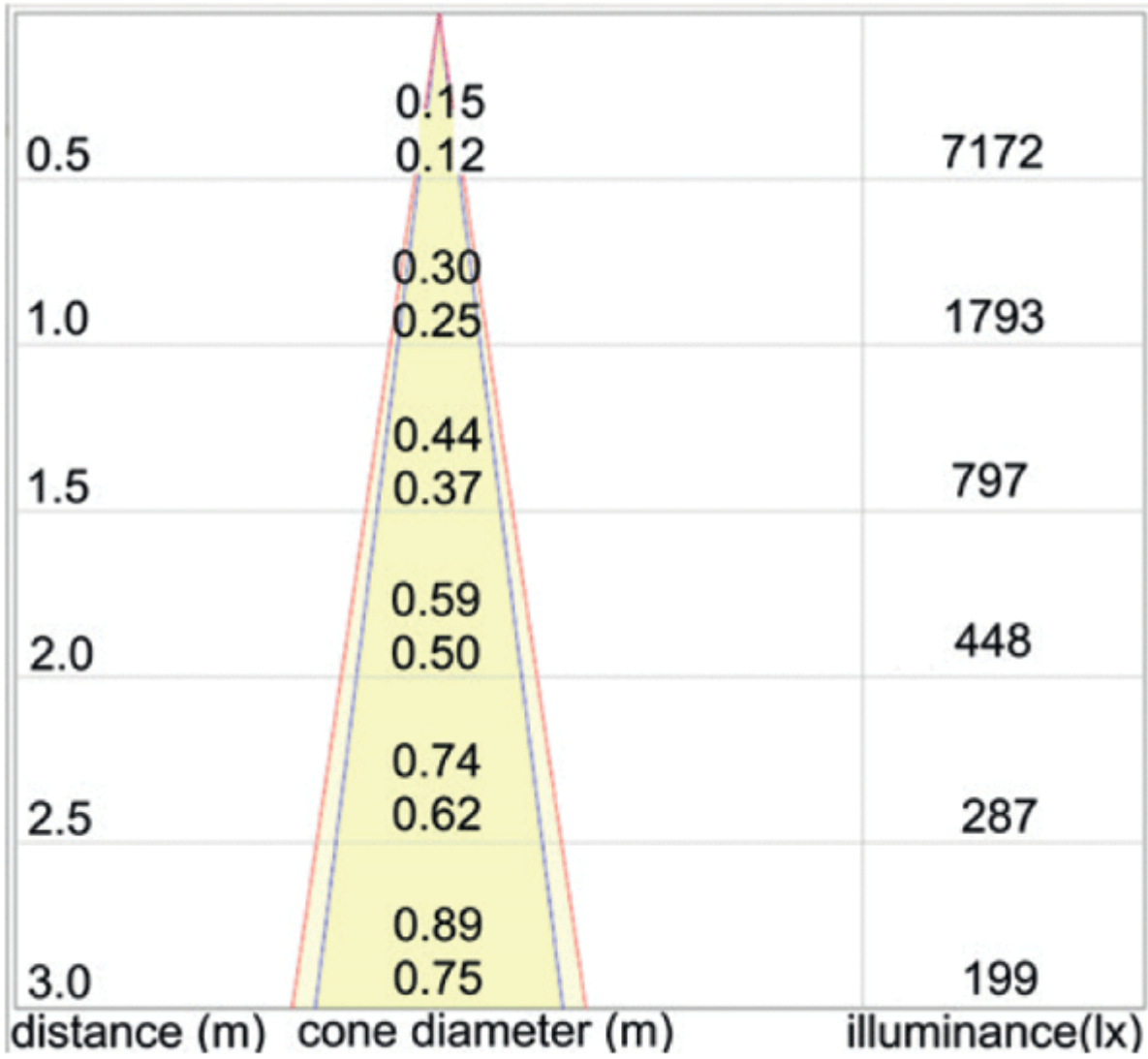

5250 14° Lens (.9N)

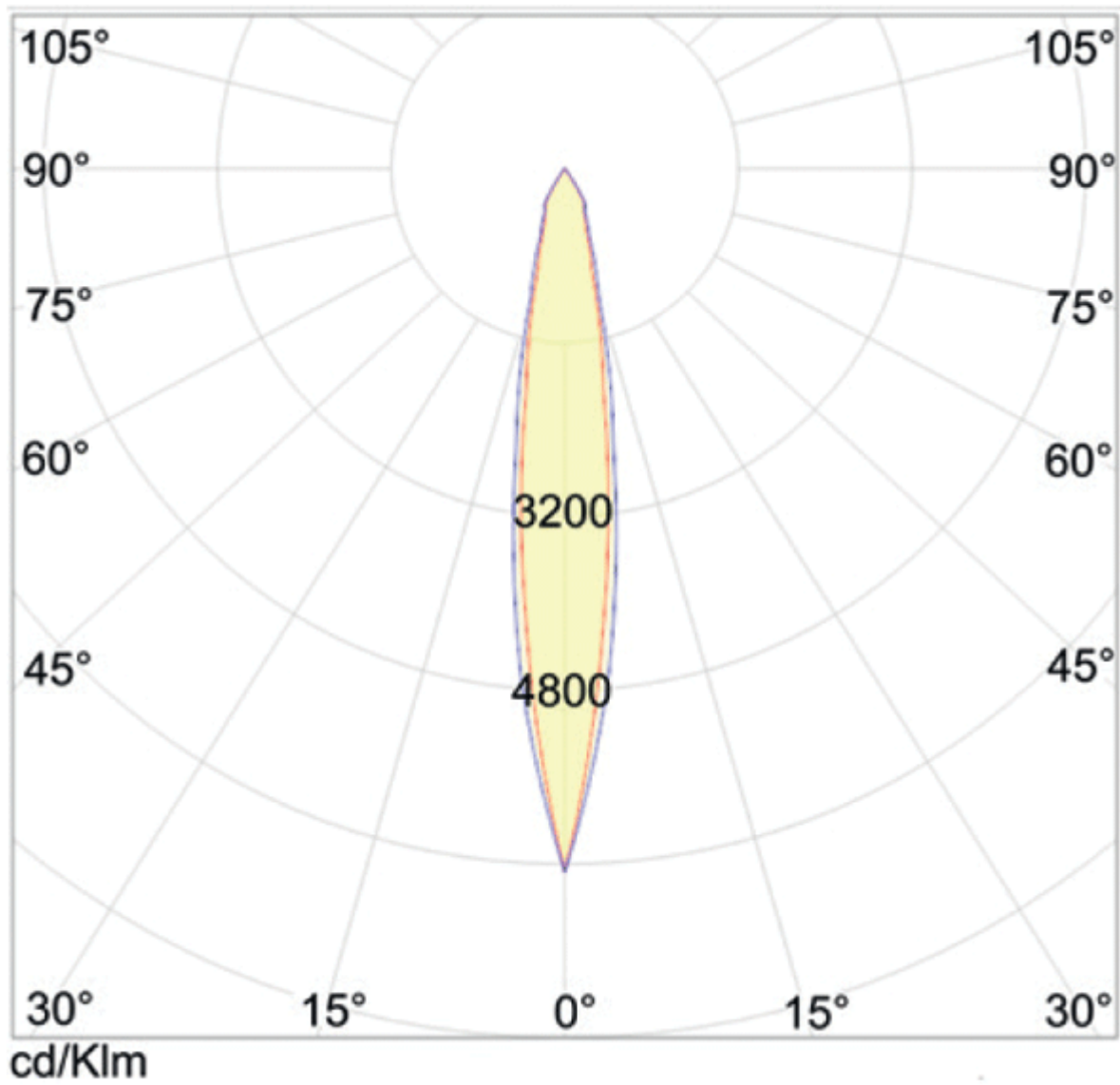

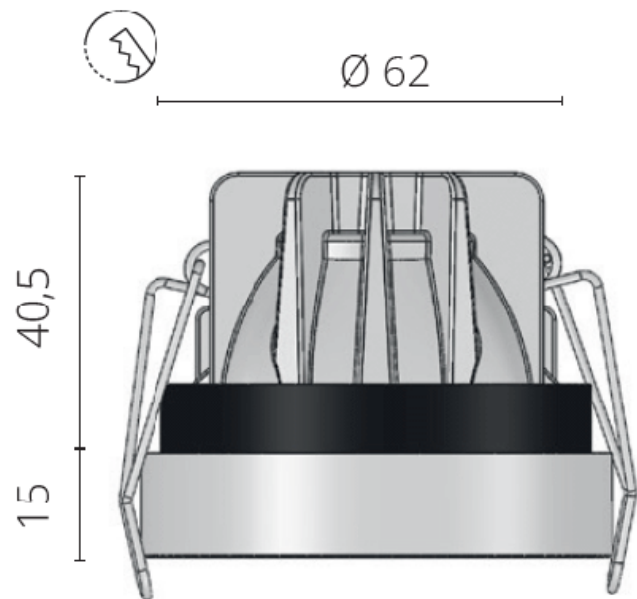
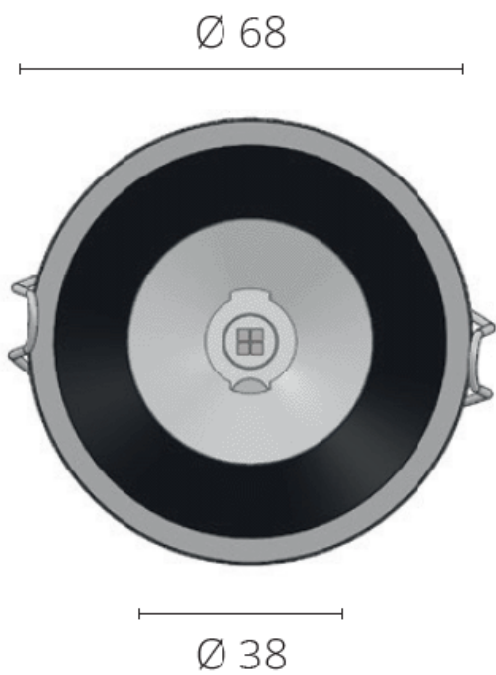

Power Led

Additional Information

| | |
|--------------------|------------------|
| Weight (kg) | 0.040000 |
| Manufacturer | Foresti & Suardi |
| Installation | Recessed |
| Light Element Type | Power LED |
| Wattage | 5W |
| Input Voltage | 10-30Vdc |
| IP Rating | IP65 |
| Dimmer | Yes |
| Bezel Size (mm) | Ø68.00 |
| Cut-out Size (mm) | Ø62.00 |
| Depth (mm) | 40.50 |
| Finish | Chrome |

Product Options

| | |
|-------------|--------------|
| LED Colour: | White 2700°K |
| | White 3200°K |
| | White 4000°K |
| | Red |
| Lens Angle: | 14° |
| | 29° |
| | 44° |

