



Radial 65 - PVC Fender Profile

Product Images





Short Description

One of our most popular ranges of fender profile is Radial. The high-quality, durable, and attractive Patented Radial Rub Rail is perfect for all marine environments, on yachts, sailing boats, motorboats, docks, wharves, and much more!

Unlike many of our its competitors, Tessilmare Rub Rails can be bought in easy to install custom lengths. This cuts down on waste and reduces costs. With its soft and seamless inserts and custom lengths, Radial Rub Rails by Tessilmare is the number one choice for all marine installations.

The Radial Rub Rails are available in two easy to install, and budget friendly, matching joint and end cap options in polished stainless steel. Rub Rails feature seamless installation, custom cut lengths, easy to repair, and fast refit.

Description

Selling Information

- The Radial Rub Rail comes manufactured in two separate pieces, a soft external Marine PVC profile and a PVC rigid bar inside, produced in custom made lengths up to a maximum roll length of 300 metres.
Please note that there is a minimum order quantity of 24 metres for this product.
- Available in three colors: white-black-grey

Materials

- **Soft PVC** for marine application available in black – white- grey
- **Rigid PVC** bar made from 100% Duralene

Drawing

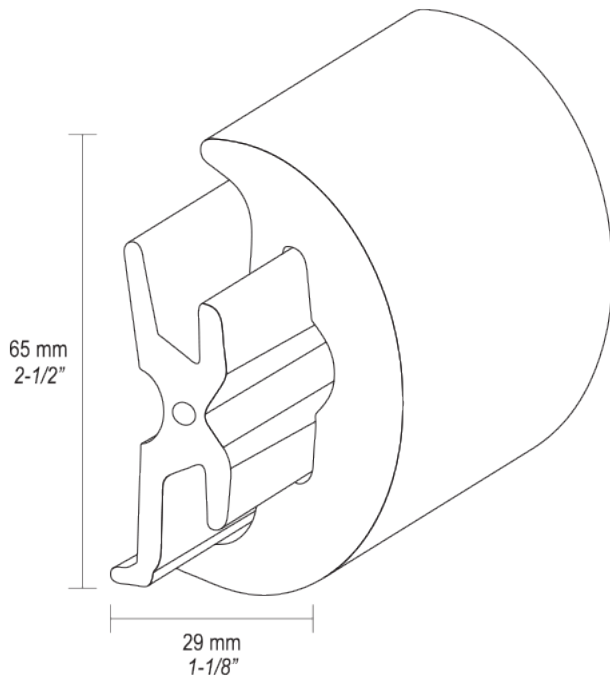

Installation

Please carefully consult the installation guide found in the downloads section of this page for more information regarding the installation of Radial. It is important that the product is installed according to the manufacturer's guidelines to ensure the correct performance of the profile.

Additional Information

Minimum Bending Radius (mm)	80.00
Radius (mm)	32.50
Base Width (mm)	42.00
Base Height (mm)	20.00
Material	PVC
Weight (kg)	1.652000
Manufacturer	Tessilmare

